

- INSTRUCTION MANUAL -

CPH 20

Ø50 X H49

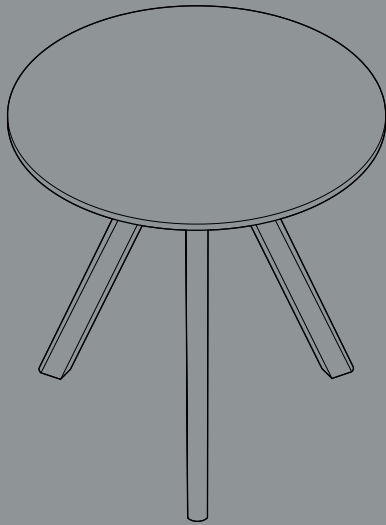

DESIGN BY RONAN & ERWAN BOUROULLEC

HAY

- PARTS -

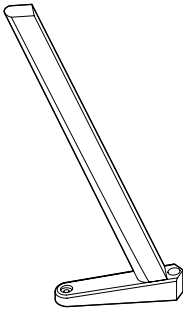

A Leg x3

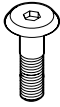

B Screw x3

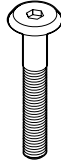

C Screw x3



D Allen key

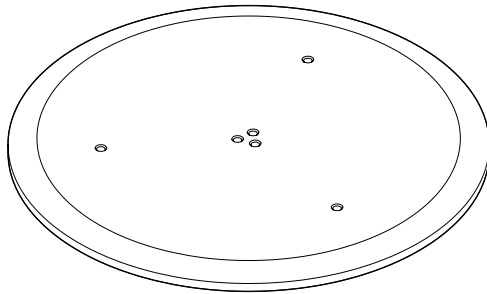

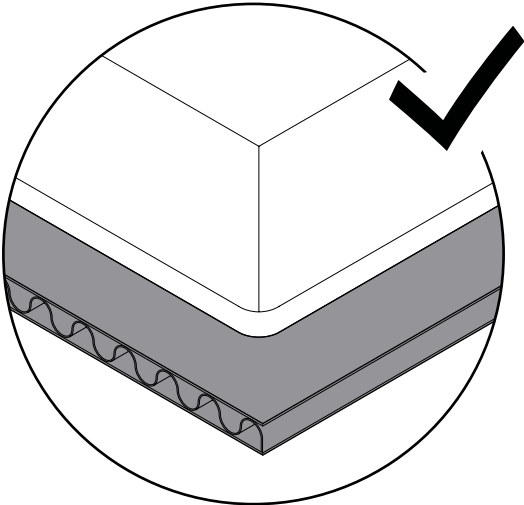
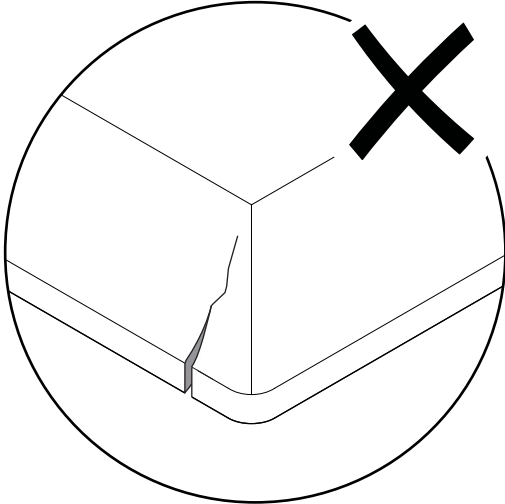

E Table top x1

Protect the table top from scratches and other damage while assembling.

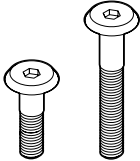

1.

Place the legs **A** on the table top **E** and fasten them with the screws **B** and **C** using the Allen key **D**. Make sure all the screws are inserted and tightened loosely, before tightening them completely.

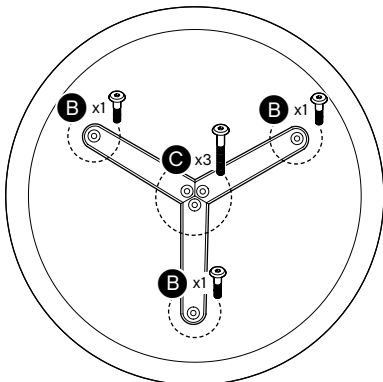
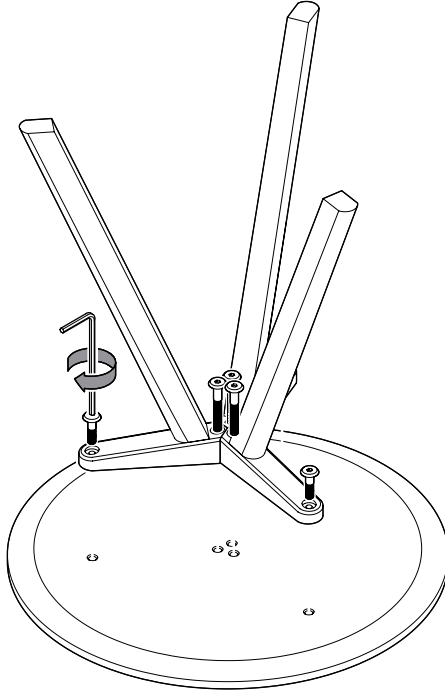

B **C**

ATTENTION

Be aware of the different lengths of the screws. Using the incorrect screw could damage the table.

2.

Turn the table over. (2 persons recommended).

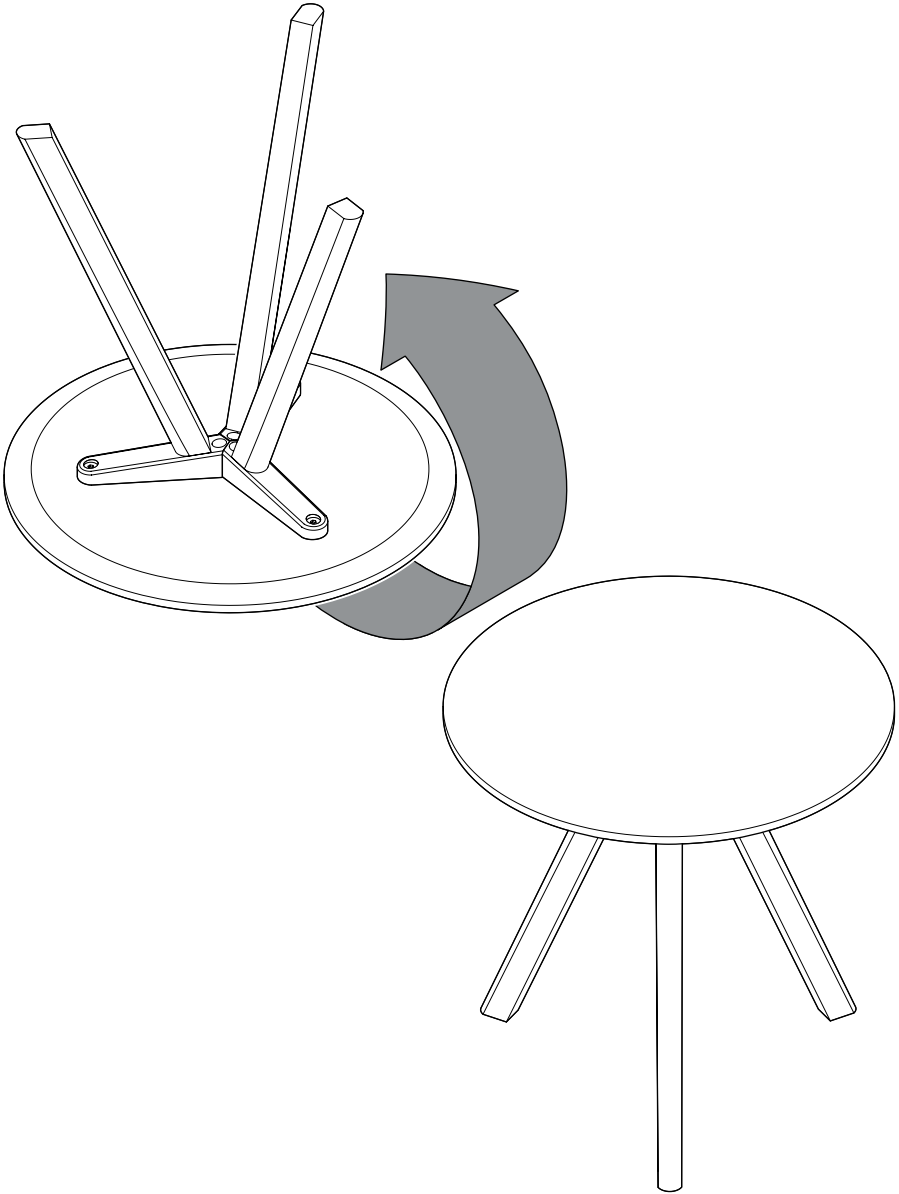

- INSTRUCTION MANUAL -

CPH 20

Ø70 X H105

Ø90 X H74

Ø120 X H74

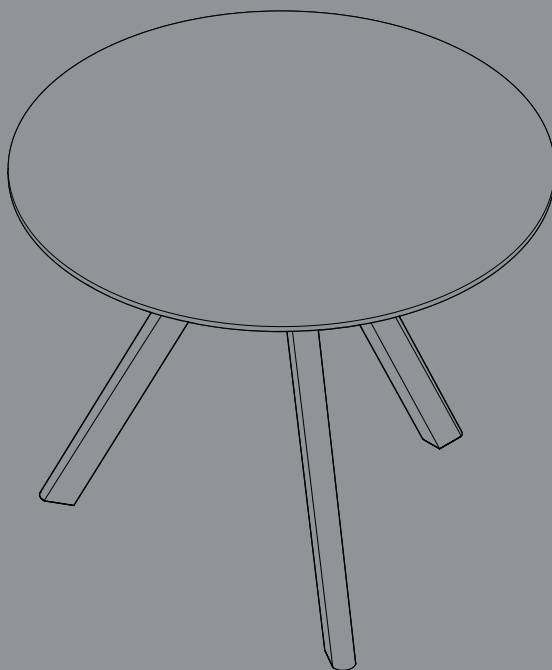

HAY

- PARTS -

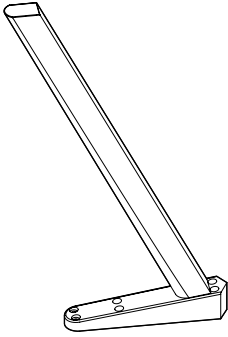

A Leg x3

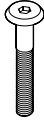

B Screw x12

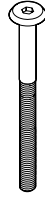

C Screw x6



D Allen key

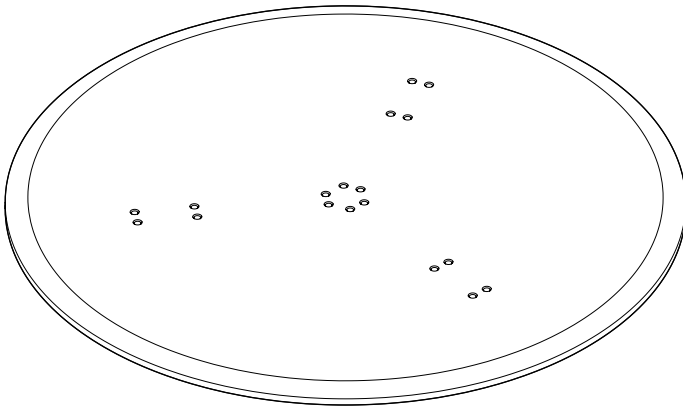

G Table top x1

Protect the table top from scratches and other damage while assembling.

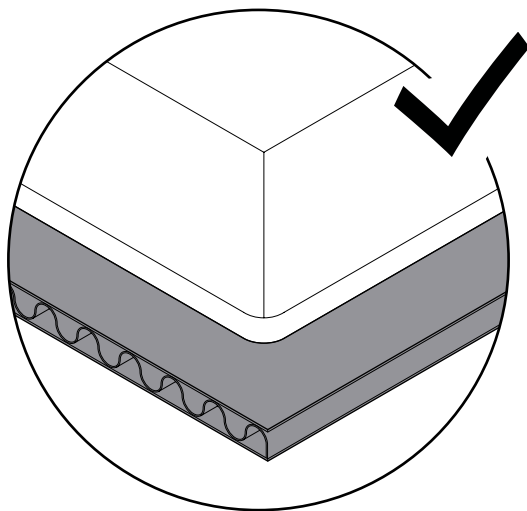
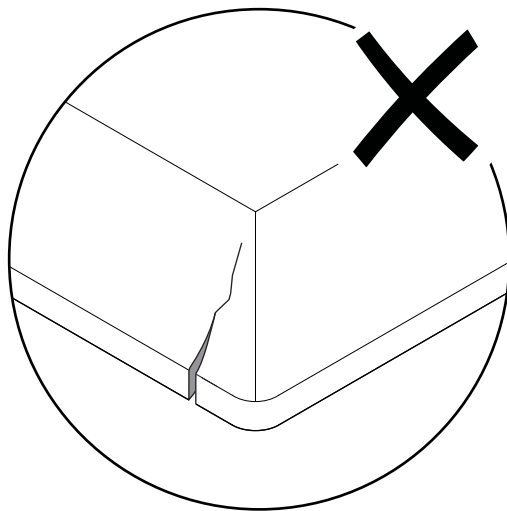

1.

Place the legs **A** on the table top **E** and fasten them with the screws **B** and **C** using the Allen key **D**. Make sure all the screws are inserted and tightened loosely, before tightening them completely.

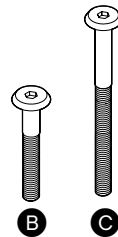
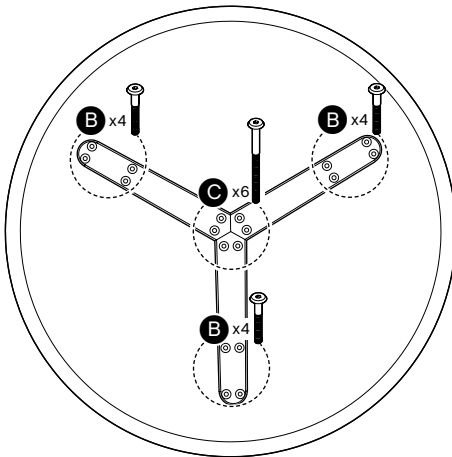
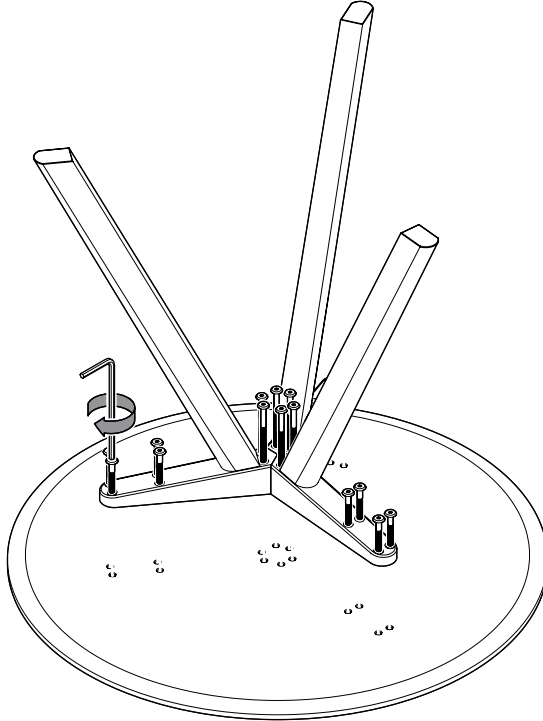

ATTENTION

Be aware of the different lengths of the screws. Using the incorrect screw could damage the table.

2.

Turn the table over. (2 persons recommended).

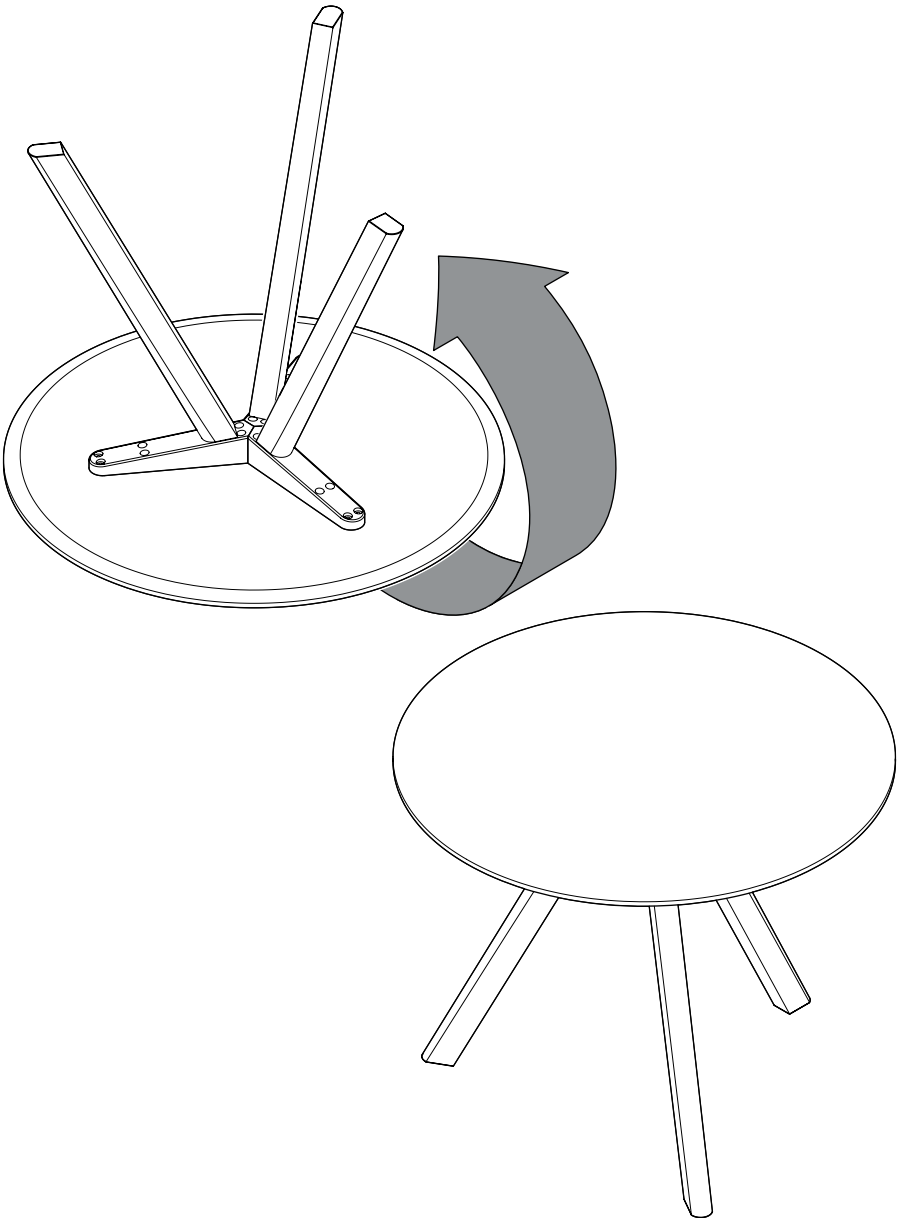

Our Care & Maintenance offers guidance for optimal maintenance of your HAY product. It includes advice and instructions on cleaning and caring for specific materials to prolong the life of your furniture.



Please find our Care & Maintenance guide by scanning the QR code



You can find more relevant information on CPH 20 by scanning the QR code

You can also find the same information here
hay.dk/downloads

Havnen 1 8700 Horsens Denmark
+45 4282 0282 / hay@hay.com

05/03/2021

HAY